

CS

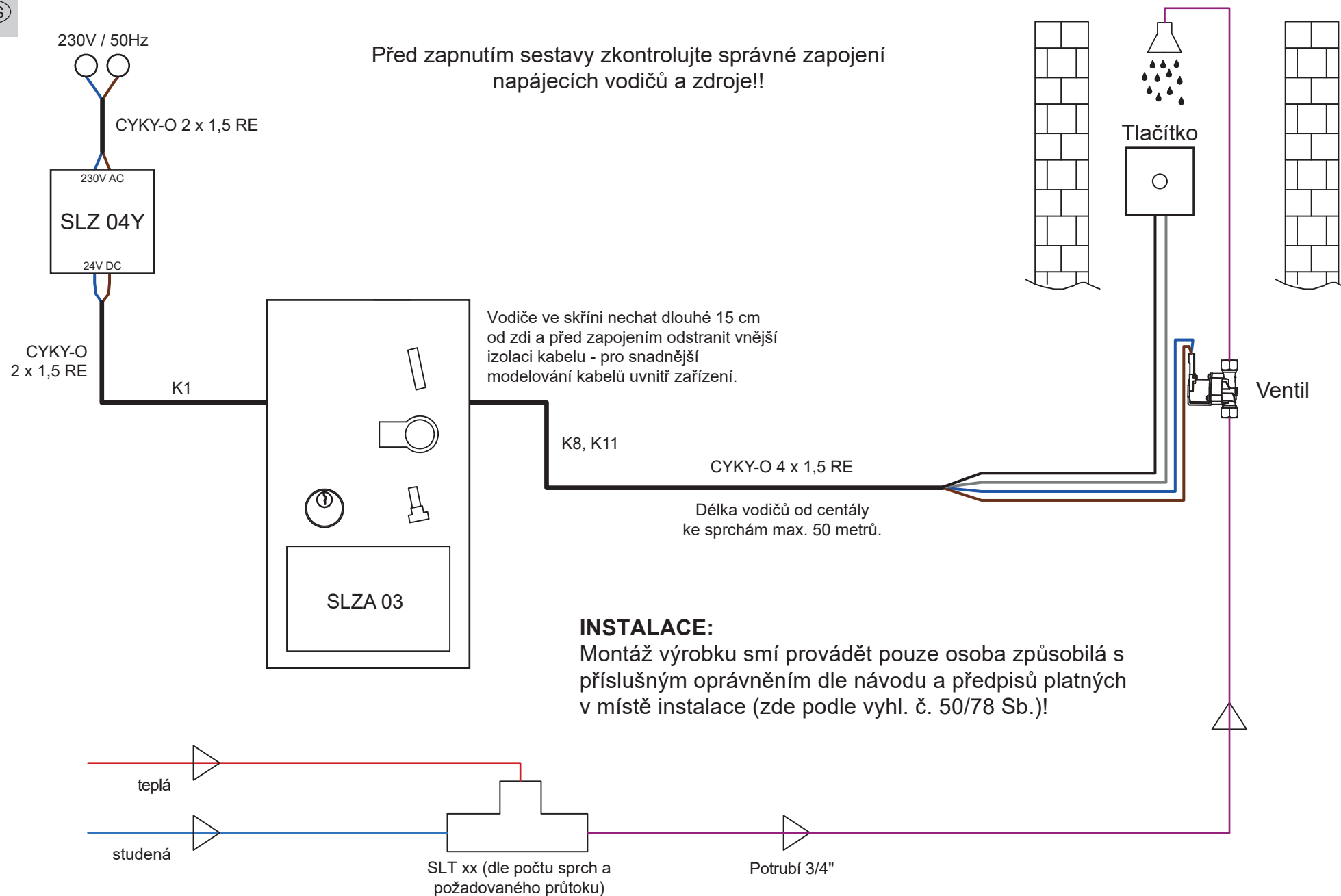

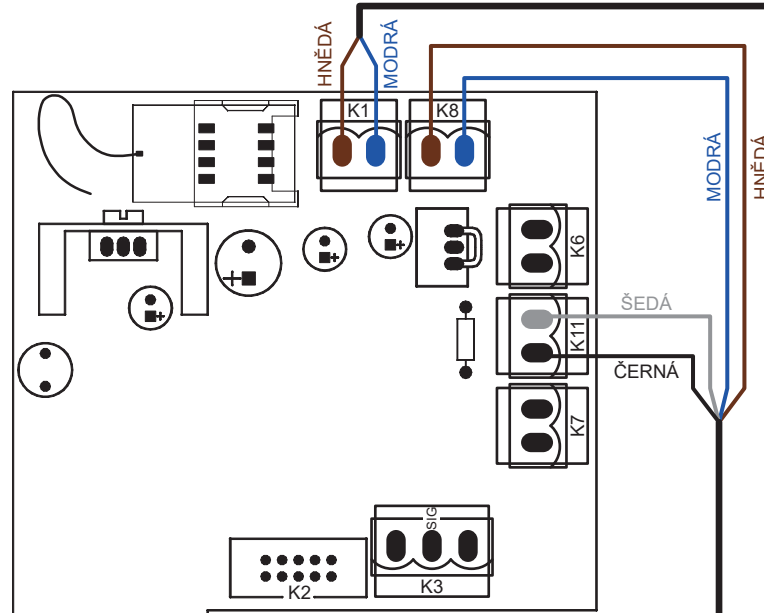

K1 napájení 24V DC
K2 mincovník
K8 ventil
K11 tlačítko

Detail
DPS

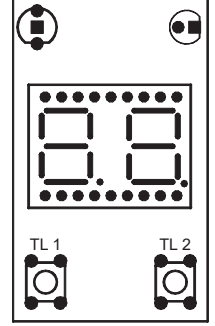

K1 - hnědá, modrá

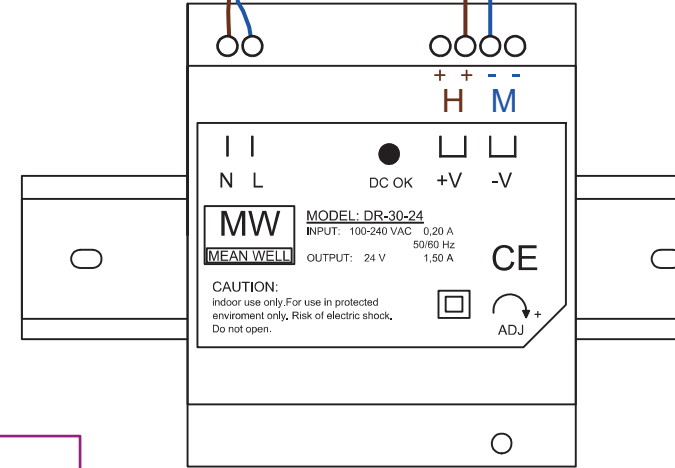

DIN lišta

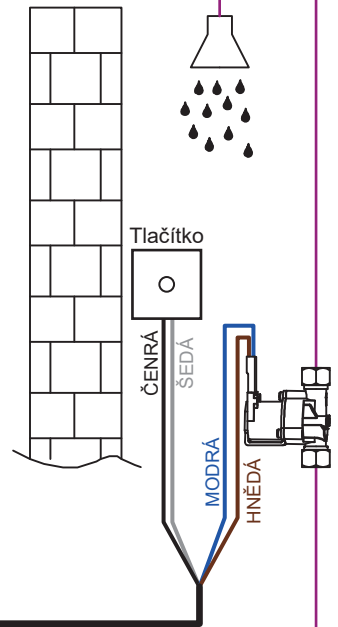

K8 - hnědá, modrá
K11 - černá, šedá

230V / 50Hz



CYKY-O 2 x 1,5 RE



Before switching on the module, check the correct connection of the power cables and the power supply!!

CYKY-O 2 x 1,5 RE

K1

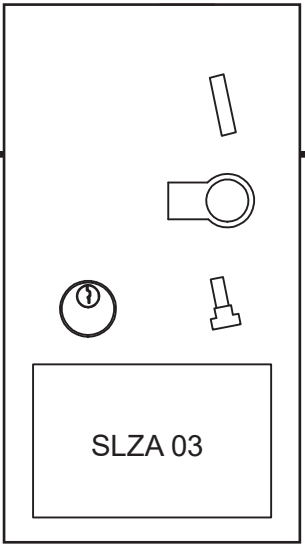

Wires in the box must be min. 15 cm long (from the wall). Before installation, remove the outer cable insulation for easier handling in the box.

K8, K11

CYKY-O 4 x 1,5 RE

The cable length from the central unit to the shower can be a maximum of 50 meters.

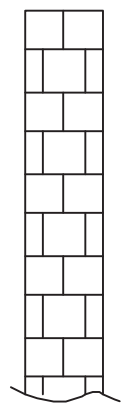

Button

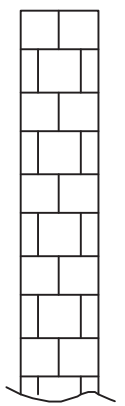
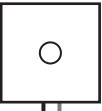

Valve

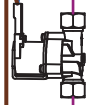

INSTALLATION:

Installation of the product may only be carried out by qualified persons with the appropriate authorization in accordance with the instructions and regulations at the installation site!

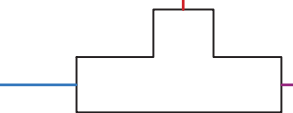
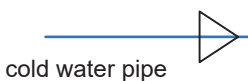

Thermostat SLT xx (depending on the number of showers and the required flow).



Pipe 3/4"



Detail of DPS

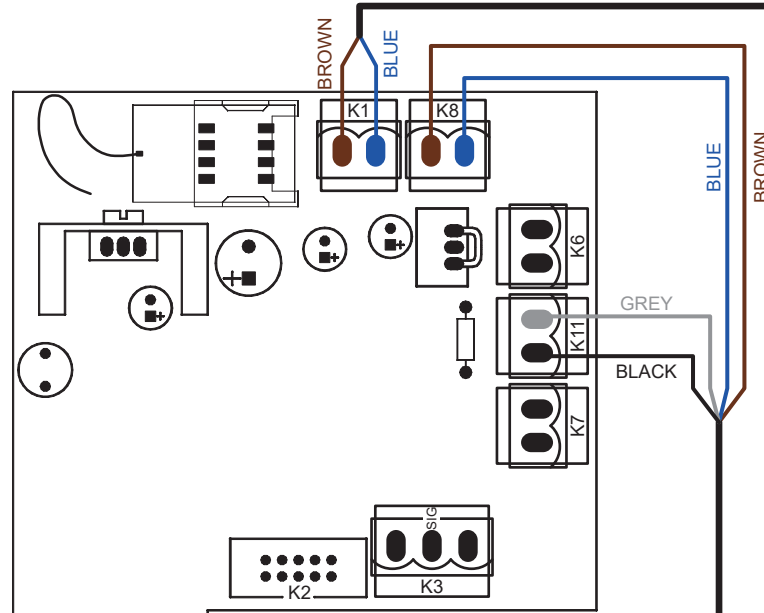

- K1 power supply 24V DC
- K2 coin unit
- K8 valve
- K11 button

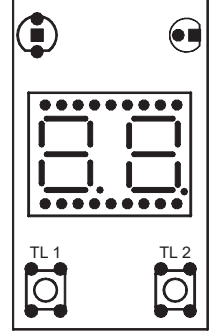

K1 - blue, brown



24V DC

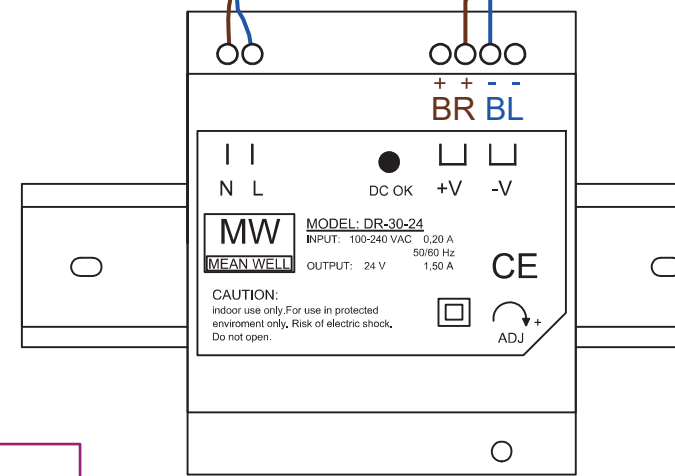

DIN rail (only for SLZ 04)

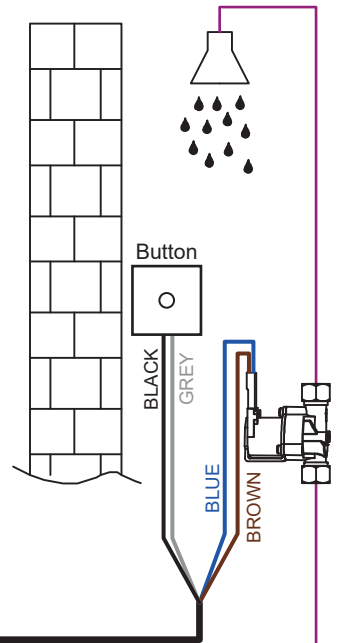

K8 - blue, brown
 K11 - grey, black

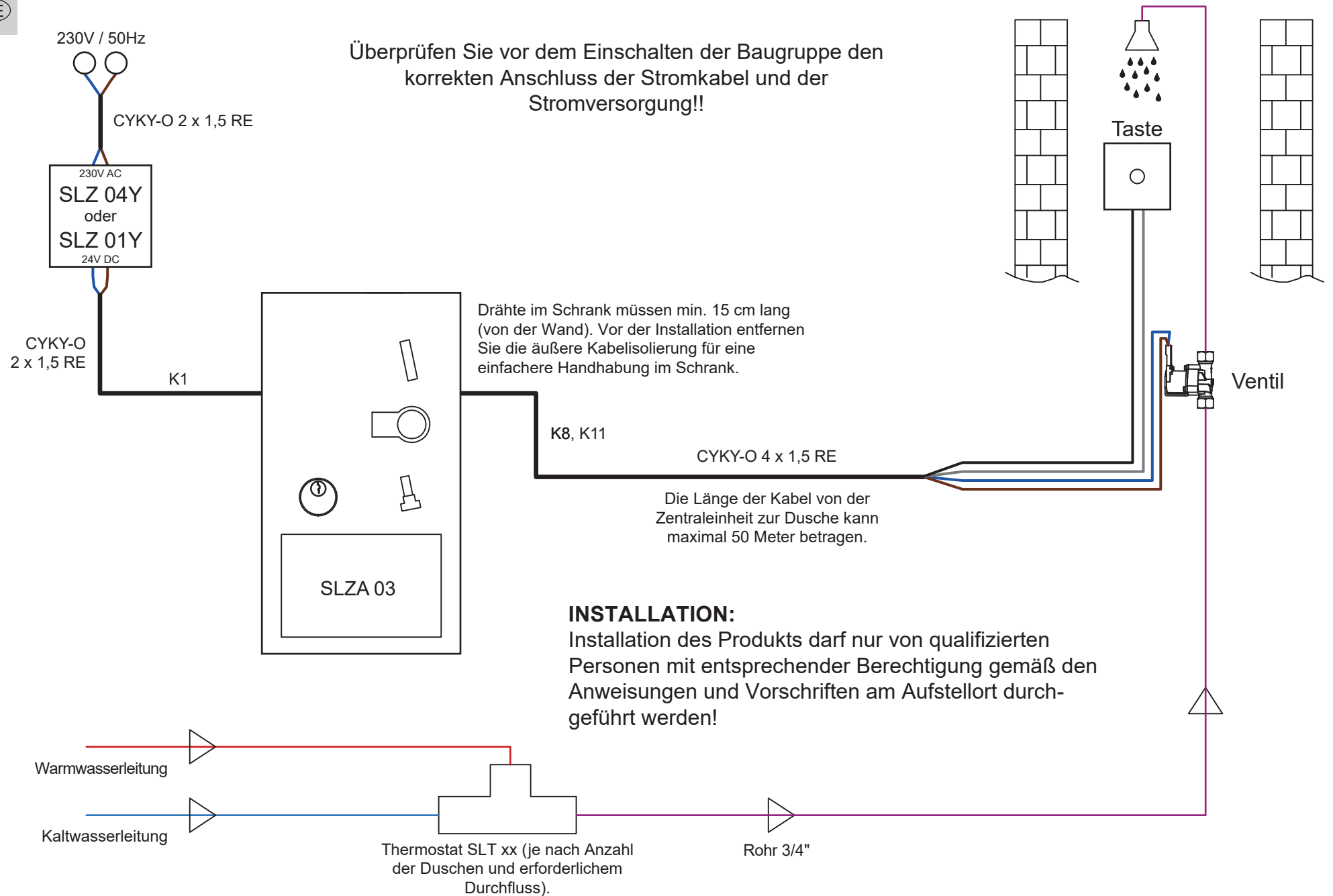

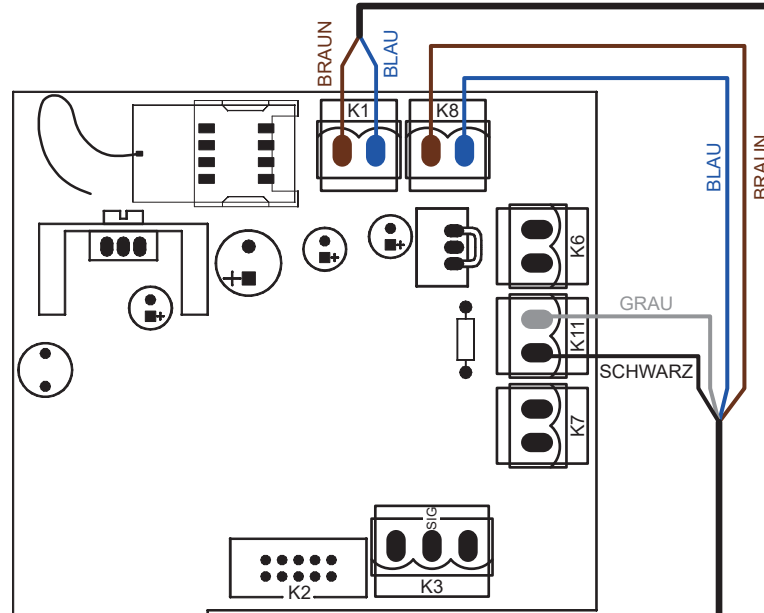

DPS Detail

- K1 Netzteil 24V DC
- K2 Münzeinheit
- K8 Ventil
- K11 Taste

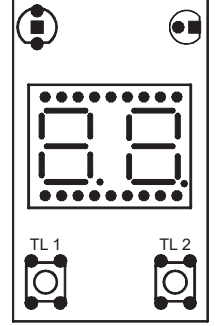

K1 - blau, braun



24V DC

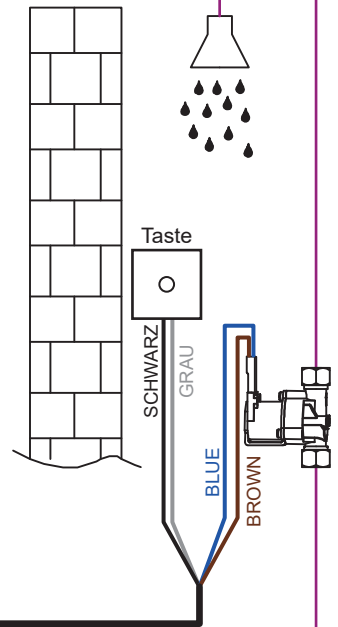
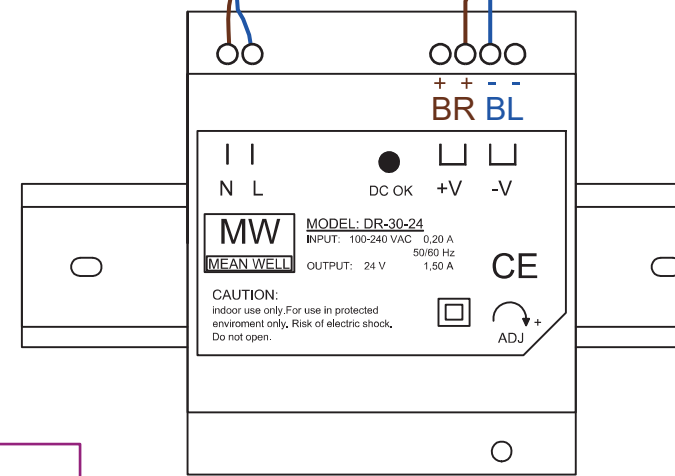

K8 - blau, braun
 K11 - grau, schwarz